

ESTAIEN GARAPENA DESARROLLO DE LOS DIFERENTES PISOS

Bankua Banco

Frisoaren egituraren xehekapena / Desglose de la estructura del friso
Zuren identifikazioa / Identificación de maderas

Gaztaina / Castaño ■
Intxaurra / Nogal ■
Ezka / Tilo ■
Haritza / Roble ■

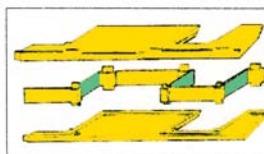

Bankuazpia Sotobanco

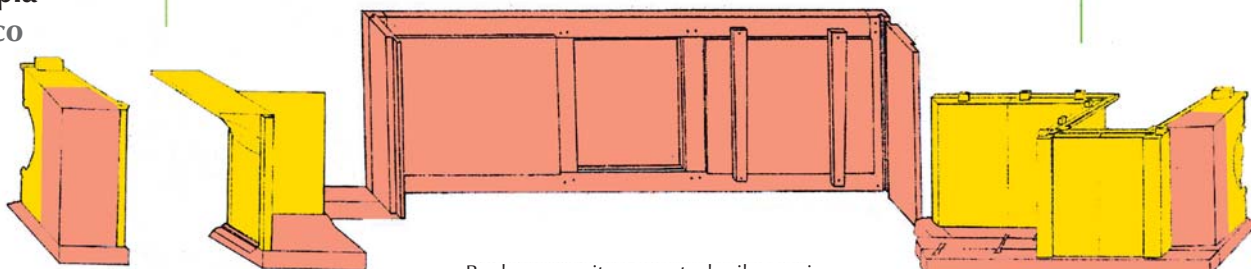

Bankuaren egituraren atzeko ikuspegia
Vista trasera de la estructura del banco



Banku barrenaren oinarriaren oinplanoa
Planta de la base sotobanco

1. estaia 1^{er} piso

Estaiaren egituraren xehekapena
Desglose de la estructura del piso

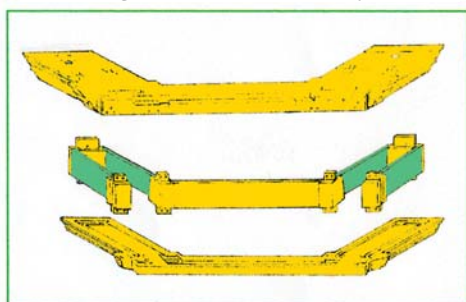

Adibiderako horma-konka,
zurak identifikatuta

Ejemplo de hornacina con
identificación de maderas

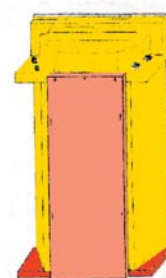

■ Eraikuntza markak
Marcas de construcción

Frisoaren atzealdeko ikuspegia
Vista trasera del friso



Banku barreneko taulamenduaren oinplanoaren azpiko ikuspegia
Vista inferior de la planta del entablamiento del sotobanco

2. estaia
2º piso

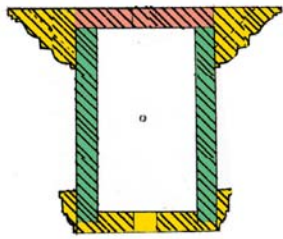

Egituraren aurrealdeko ikuspegia
Vista frontal de la estructura

Mazizoa
Macizo

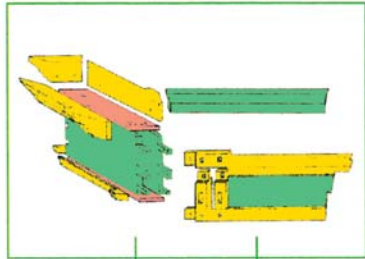

Egituraren xehekapena
Desglose de la estructura

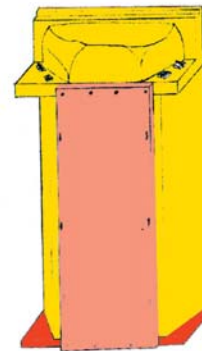

Adibiderako horma-konka,
zurak identifikatuta
Ejemplo de hornacina con
identificación de maderas

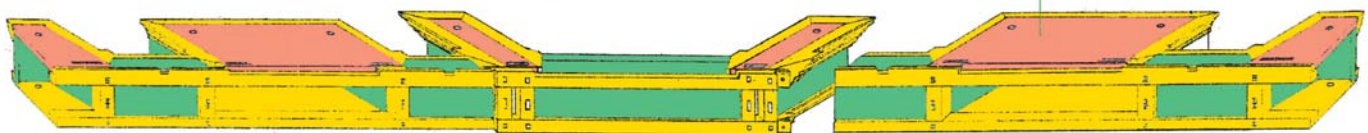

3. estaia
3er piso

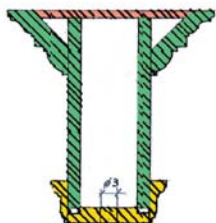

Mazizoa
Macizo



Molduren marrazkiak
Dibujos de molduras

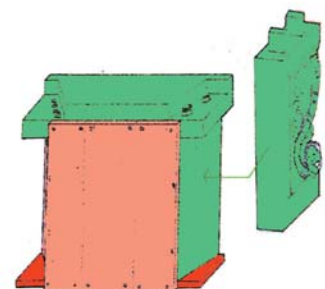

Adibiderako horma-konka, zurak identifikatuta
Ejemplo de hornacina con identificación de maderas

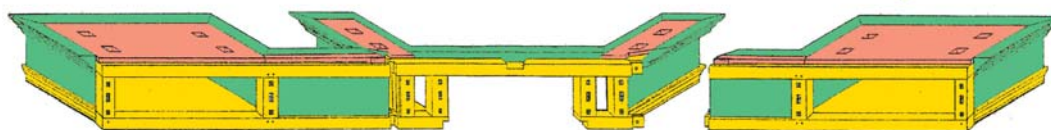

Frisoaren atzealdeko ikuspegia
Vista trasera del friso

Atikoa
Ático

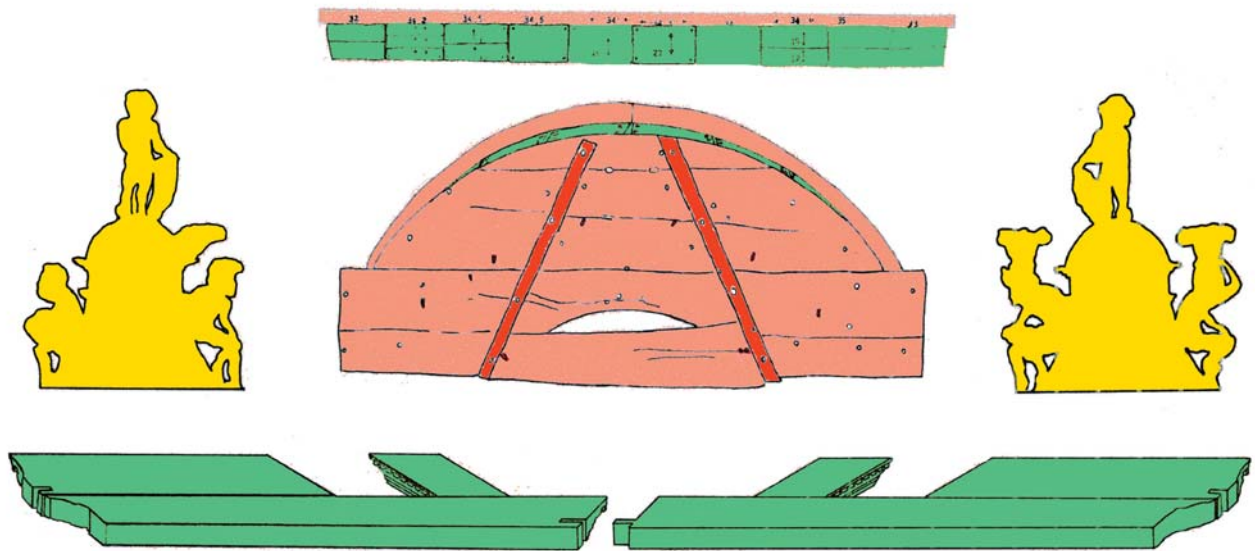

Frisoaren atzealdeko ikuspegia
Vista trasera del friso

